

# Modulate Magnetic Kit 30-02

MOD-30-02-M-TL  
MOD-30-02-M-TL-OCE

Modulate™ Fabric Banner kits feature unique angles and shapes, are portable and now are even easier to configure to achieve your dream space! Modulate now offers magnets to attach frames and keep them securely connected together. Choose from multiple frame shapes to design your own combinations – walls, booths, conference rooms, storage areas – the possibilities are endless! The aluminum tube frames feature snap-button connections that are coupled with a printed pillowcase fabric graphic that slips over the frame and zips closed at the bottom. Twist-lock feet connect the tube frames at the bottom of the display. Each frame comes in a durable, portable carry bag.



This product may include the following materials for recycle: aluminum, select wood, fabric, cardboard, paper, steel, and plastics.

We are continually improving and modifying our product range and reserve the right to vary the specifications without prior notice. All dimensions and weights quoted are approximate and we accept no responsibility for variance. E&OE. See Graphic Templates for graphic bleed specifications.

## features and benefits:

- Magnetized premium aluminum tube frame with snap button assembly
- Easy to store and ship
- Quick to set up
- Weighted feet for added stability
- Comes with carry bag and box
- Zipper pillowcase fabric graphics
- Lifetime limited hardware warranty against manufacturer defects

## dimensions:

Hardware

Graphic

Assembled unit:  
350.53" w x 96" h x 17.72" d  
8904mm(w) x 2438mm(h) x 450mm(d)

Refer to related graphic template for more information.

Approximate weight:  
107 lbs / 49 kg

Visit:  
<https://www.theexhibitorshandbook.com/download-graphic-templates>

## Shipping

## additional information:

### Packing Option 1: MOD-30-02-M-TL

Graphic material:  
Dye-sublimation zipper pillowcase fabric

7 Boxes: 48" l x 12" h x 5" d  
1220mm(l) x 305mm(h) x 127mm(d)

When included in a larger kit, a different packaging solution will be listed to accommodate all contents of the kit. Individual packaging no longer provided.

Approximate shipping weight:  
121 lbs / 55 kg

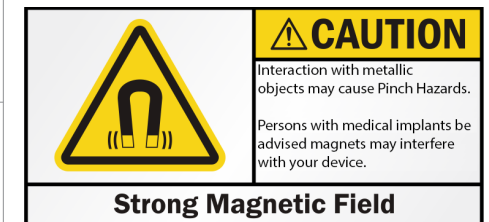

### Packing Option 2: MOD-30-02-M-TL-OCE

3 OCE: Expandable case length (l) may vary  
40" - 66" l x 18" h x 18" d  
1016mm-1677mm(l) x 458mm(h) x 458mm(d)

Approximate shipping weight:  
211 lbs / 96 kg

Use caution when handling this product around mechanical wrist watches, metal tools, electronic devices, credit cards or any other similar items. DO NOT place any part of the body, such as fingers, hands, etc, between the magnetic surface areas of the components.

# Included In Your Kit



MOD-FRM-09-M-TL x3



MOD-FRM-10-M-TL x2



MOD-FRM-11-M-TL x2

	<b>CAUTION</b> Interaction with metallic objects may cause Pinch Hazards.
	Persons with medical implants be advised magnets may interfere with your device.
<b>Strong Magnetic Field</b>	

Use caution when handling this product around mechanical wrist watches, metal tools, electronic devices, credit cards or any other similar items. DO NOT place any part of the body, such as fingers, hands, etc, between the magnetic surface areas of the components.

# Suggested Kit Layout

## MOD-30-02-M-TL

MOD-FRM-10-M-TL

MOD-FRM-11-M-TL

MOD-FRM-09-M-TL

MOD-FRM-09-M-TL

MOD-FRM-09-M-TL

MOD-FRM-11-M-TL

MOD-FRM-10-M-TL

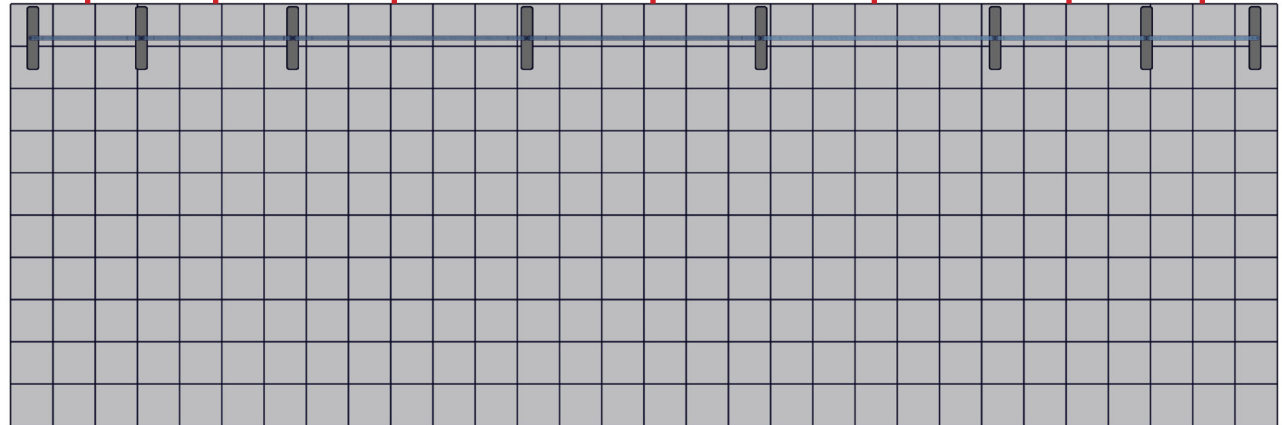
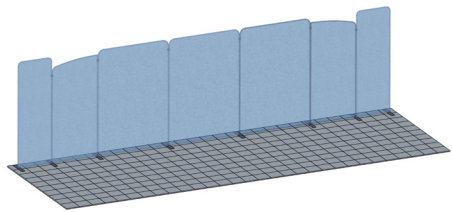

	<b>CAUTION</b>
	Interaction with metallic objects may cause Pinch Hazards. Persons with medical implants be advised magnets may interfere with your device.
<b>Strong Magnetic Field</b>	

Use caution when handling this product around mechanical wrist watches, metal tools, electronic devices, credit cards or any other similar items. DO NOT place any part of the body, such as fingers, hands, etc, between the magnetic surface areas of the components.

# Modulate Frame 09

## MOD-FRM-09-M-TL

Modulate™ Fabric Banners feature unique angles and shapes, are portable and now are even easier to configure to achieve your dream space! Modulate now offers magnets to attach frames and keep them securely connected together. Choose from multiple frame shapes to design your own combinations – walls, booths, conference rooms, storage areas – the possibilities are endless! The aluminum tube frames feature snap-button connections coupled with a printed pillowcase fabric graphic to slip over the frame and zip closed at the bottom. Twist-lock feet connect the tube frames at the bottom of the display. Each frame comes in a durable, portable carry bag.

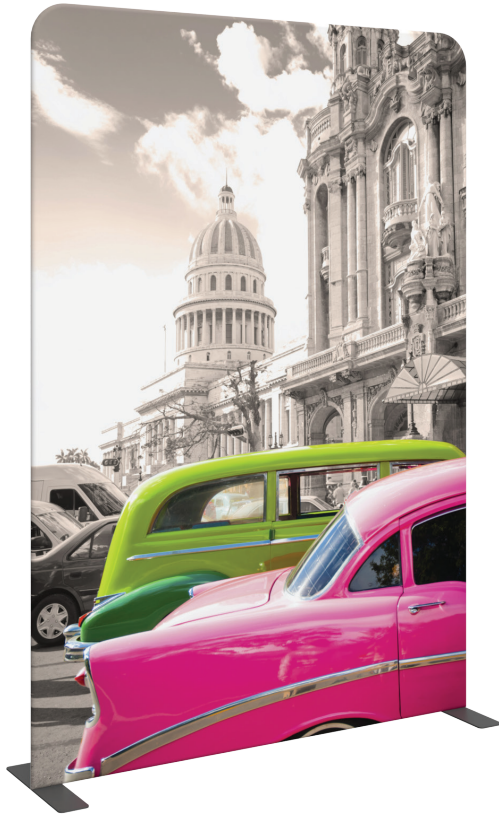

## features and benefits:

- Magnetized premium aluminum tube frame with snap button assembly
- Easy to store and ship
- Quick to set up
- Weighted feet for added stability
- Comes with carry bag and box
- Zipper pillowcase fabric graphics
- Lifetime limited hardware warranty against manufacturer defects

## dimensions:

### Hardware

Assembled unit:  
66.7" w x 96.2" h x 15.7" d  
1695mm(w) x 2444mm(h) x 399mm(d)

Approximate weight:  
15 lbs / 7 kg

### Graphic

Refer to related graphic template for more information.

Visit:  
<https://www.theexhibitorshandbook.com/download-graphic-templates>

### Shipping

Packing box(es):  
1 Box

Box size:  
48" l x 12" h x 5" d  
1220mm(l) x 305mm(h) x 127mm(d)

Approximate shipping weight:  
18 lbs / 9 kg

## additional information:

Graphic material:  
Dye-sublimation zipper pillowcase fabric

When included in a larger kit, a different packaging solution will be listed to accommodate all contents of the kit. Individual packaging no longer provided.

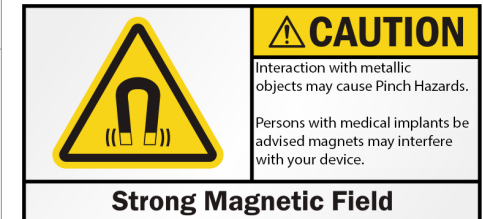

Use caution when handling this product around mechanical wrist watches, metal tools, electronic devices, credit cards or any other similar items. DO NOT place any part of the body, such as fingers, hands, etc, between the magnetic surface areas of the components.



This product may include the following materials for recycle:  
aluminum, select wood, fabric, cardboard, paper, steel, and plastics.

1 person assembly recommended:



We are continually improving and modifying our product range and reserve the right to vary the specifications without prior notice. All dimensions and weights quoted are approximate and we accept no responsibility for variance. E&OE. See Graphic Templates for graphic bleed specifications.

\*Not to scale

Bungee-Connected

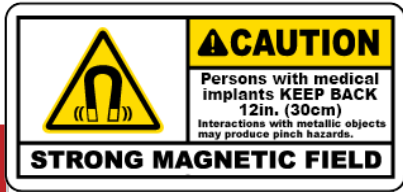

Loose

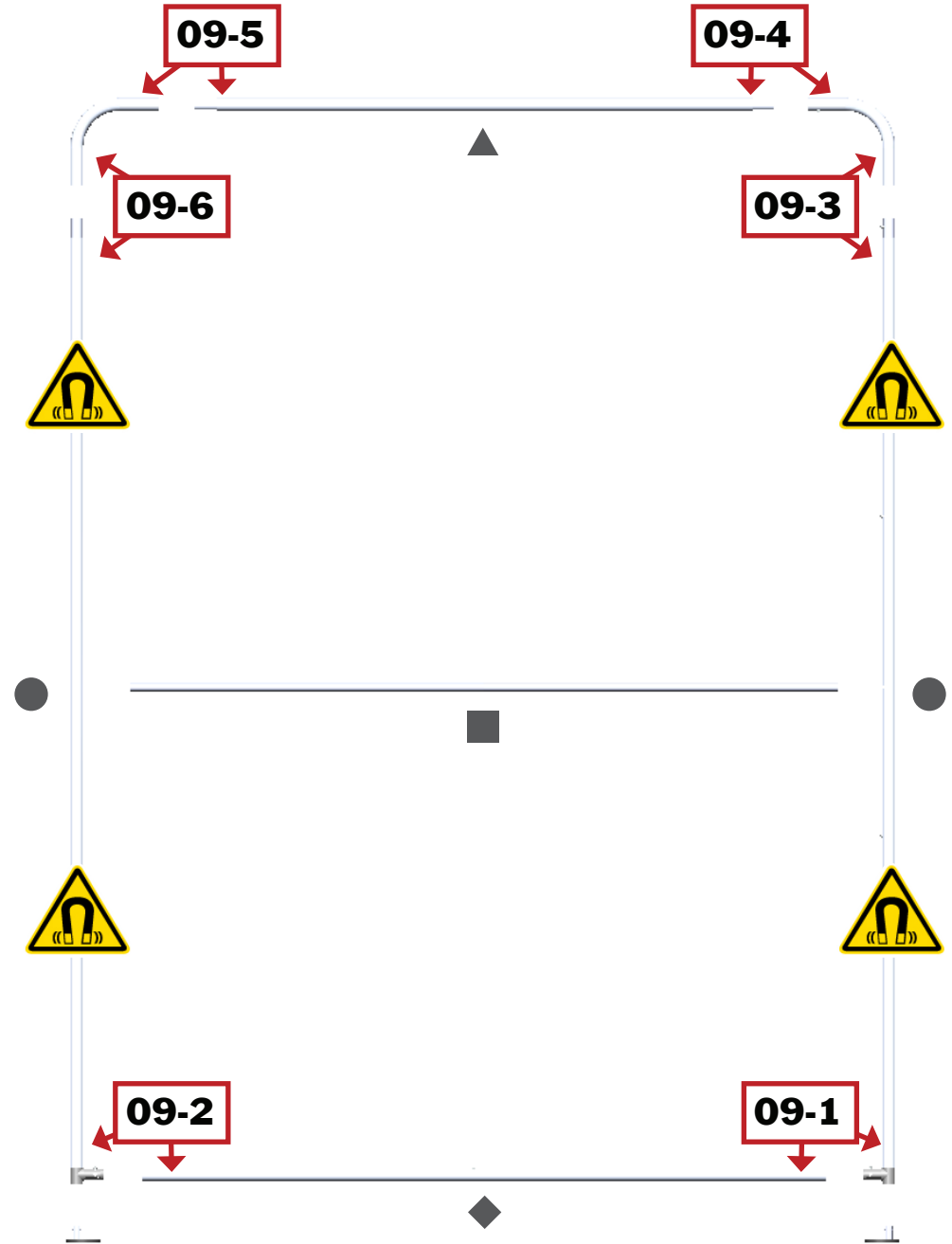
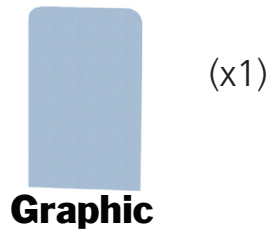
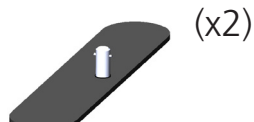
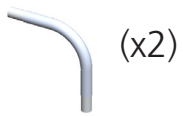

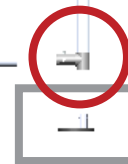
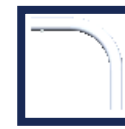
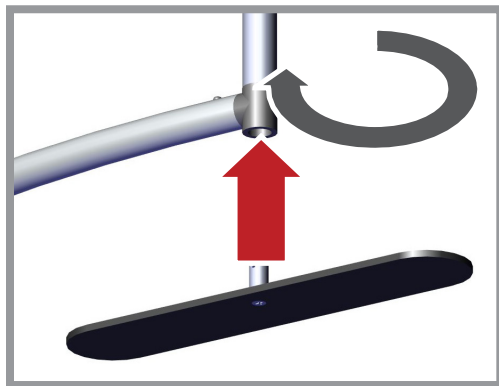
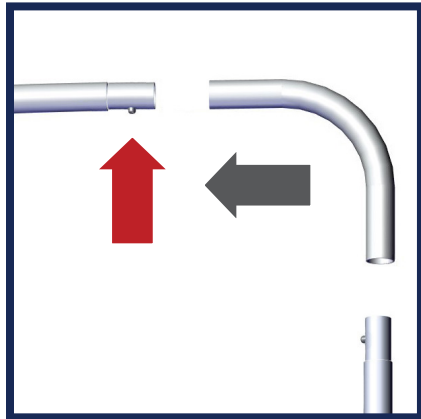
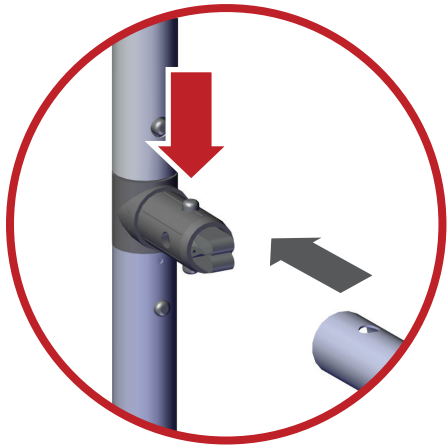

Graphic

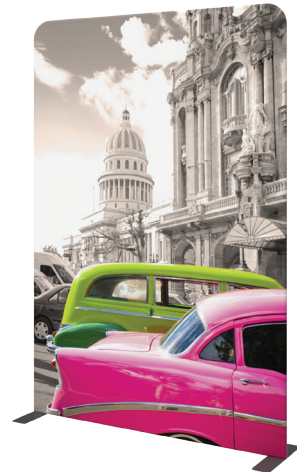
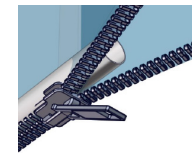
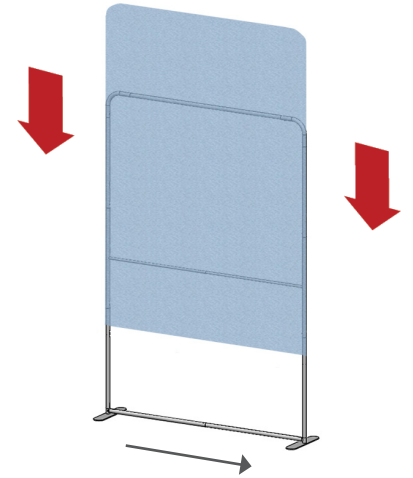

# Modulate Frame 10

## MOD-FRM-10-M-TL

Modulate™ Fabric Banners feature unique angles and shapes, are portable and now are even easier to configure to achieve your dream space! Modulate now offers magnets to attach frames and keep them securely connected together. Choose from multiple frame shapes to design your own combinations – walls, booths, conference rooms, storage areas – the possibilities are endless! The aluminum tube frames feature snap-button connections coupled with a printed pillowcase fabric graphic to slip over the frame and zip closed at the bottom. Twist-lock feet connect the tube frames at the bottom of the display. Each frame comes in a durable, portable carry bag.



## features and benefits:

- Magnetized premium aluminum tube frame with snap button assembly
- Easy to store and ship
- Quick to set up
- Weighted feet for added stability
- Comes with carry bag and box
- Zipper pillowcase fabric graphics
- Lifetime limited hardware warranty against manufacturer defects

## dimensions:

### Hardware

Assembled unit:  
32.7" w x 95.6" h x 15.7" d  
832mm(w) x 2429mm(h) x 399mm(d)

Approximate weight:  
13 lbs / 6 kg

### Graphic

Refer to related graphic template for more information.

Visit:  
<https://www.theexhibitorshandbook.com/download-graphic-templates>

### Shipping

Packing box(es):  
1 Box

Box size:  
48" l x 12" h x 5" d  
1220mm(l) x 305mm(h) x 127mm(d)

Approximate shipping weight:  
16 lbs / 8 kg

## additional information:

Graphic material:  
Dye-sublimation zipper pillowcase fabric

When included in a larger kit, a different packaging solution will be listed to accommodate all contents of the kit. Individual packaging no longer provided.

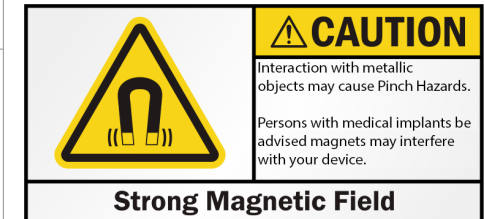

Use caution when handling this product around mechanical wrist watches, metal tools, electronic devices, credit cards or any other similar items. DO NOT place any part of the body, such as fingers, hands, etc, between the magnetic surface areas of the components.



This product may include the following materials for recycle:  
aluminum, select wood, fabric, cardboard, paper, steel, and plastics.

1 person assembly recommended:



We are continually improving and modifying our product range and reserve the right to vary the specifications without prior notice. All dimensions and weights quoted are approximate and we accept no responsibility for variance. E&OE. See Graphic Templates for graphic bleed specifications.

\*Not to scale

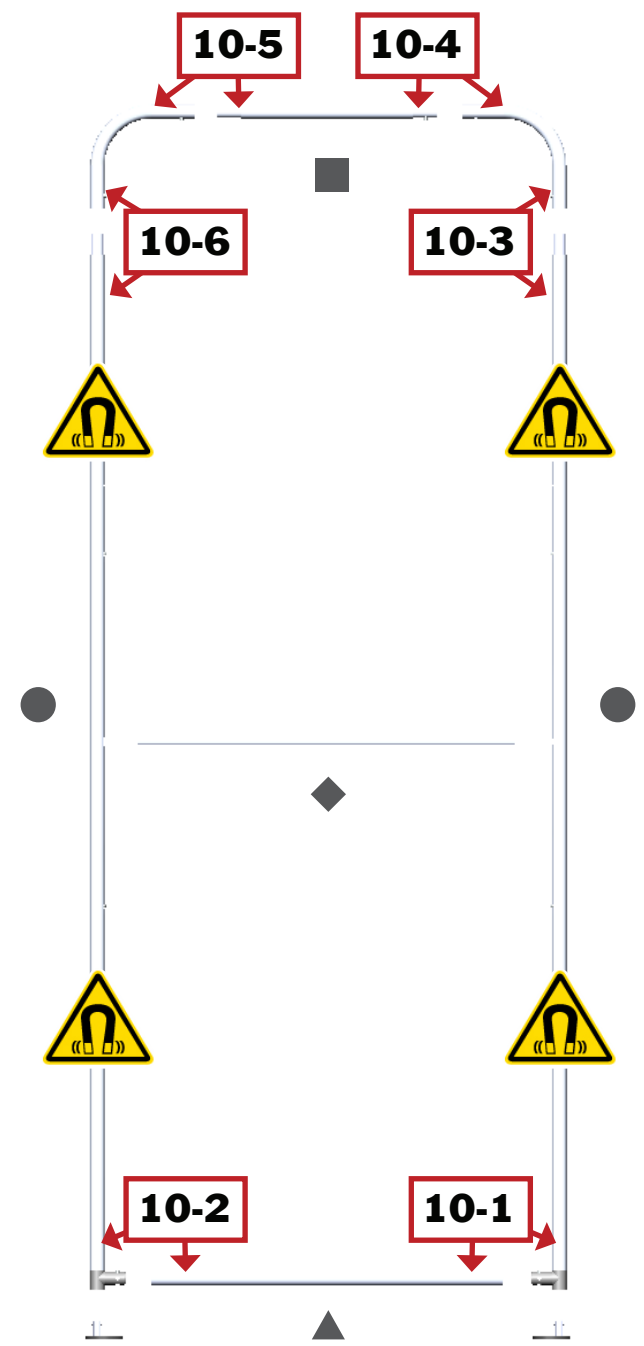
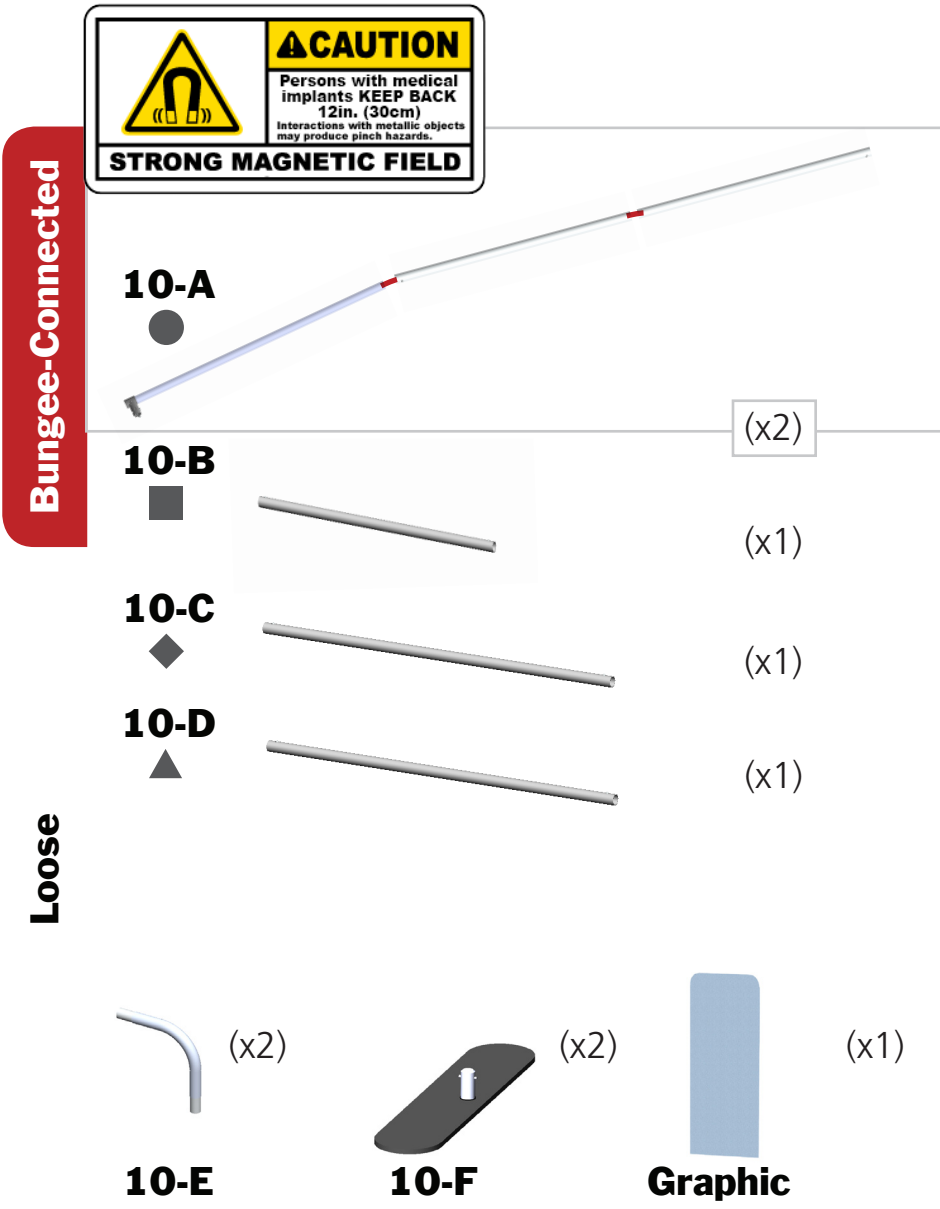



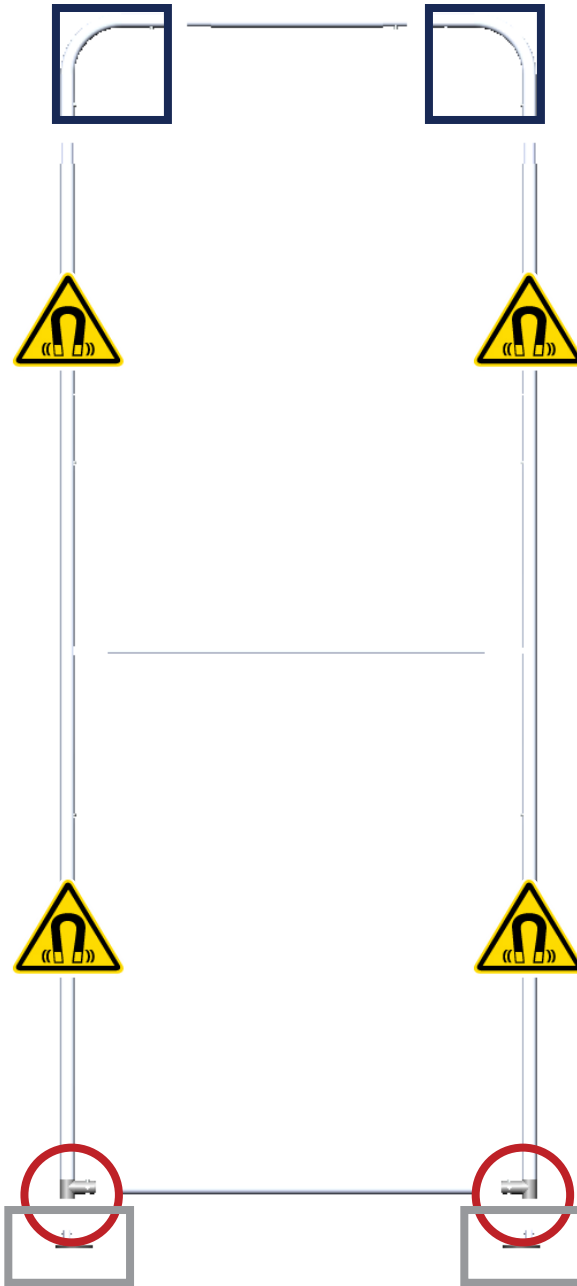
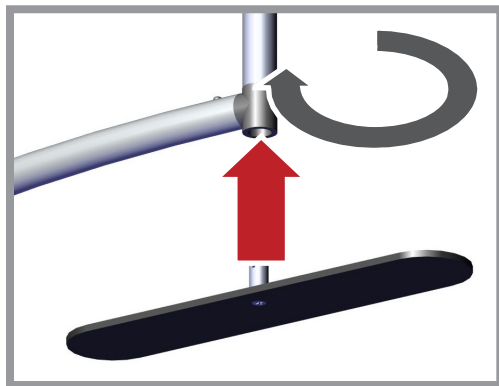
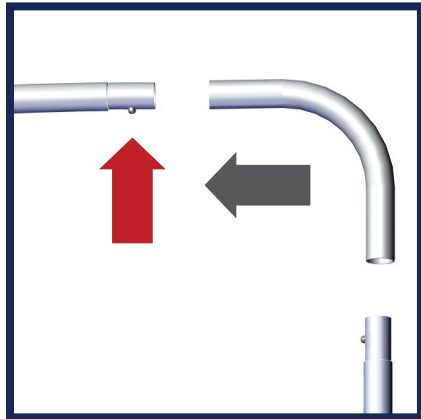
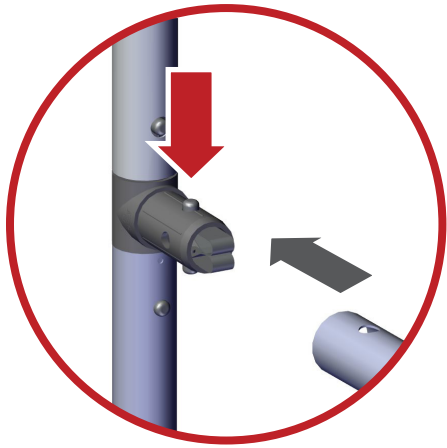

Graphic

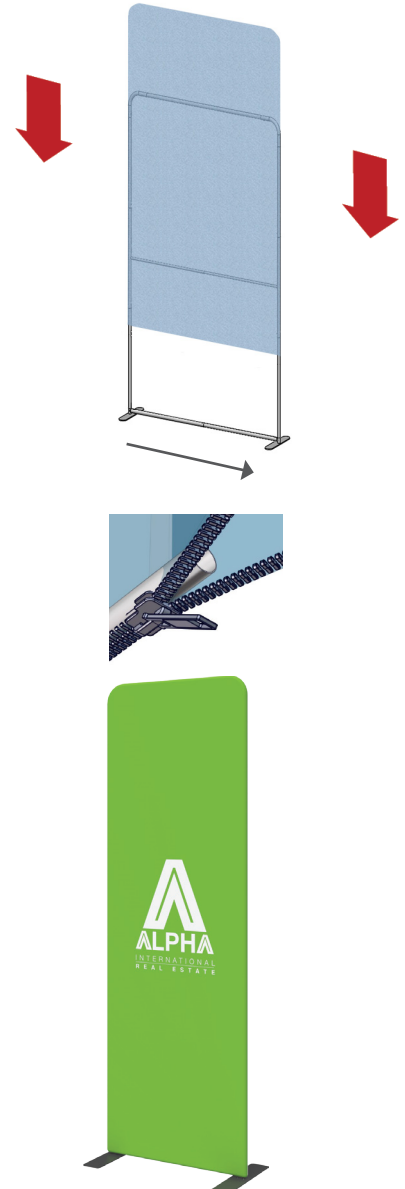

# Modulate Frame 11

## MOD-FRM-11-M-TL

Modulate™ Fabric Banners feature unique angles and shapes, are portable and now are even easier to configure to achieve your dream space! Modulate now offers magnets to attach frames and keep them securely connected together. Choose from multiple frame shapes to design your own combinations – walls, booths, conference rooms, storage areas – the possibilities are endless! The aluminum tube frames feature snap-button connections coupled with a printed pillowcase fabric graphic to slip over the frame and zip closed at the bottom. Twist-lock feet connect the tube frames at the bottom of the display. Each frame comes in a durable, portable carry bag.



## features and benefits:

- Magnetized premium aluminum tube frame with snap button assembly
- Easy to store and ship
- Quick to set up
- Weighted feet for added stability
- Comes with carry bag and box
- Zipper pillowcase fabric graphics
- Lifetime limited hardware warranty against manufacturer defects

## dimensions:

### Hardware

Assembled unit:  
43.7" w x 92.2" h x 15.7" d  
1110mm(w) x 2443mm(h) x 399mm(d)

Approximate weight:  
13 lbs / 6 kg

### Graphic

Refer to related graphic template for more information.

Visit:  
<https://www.theexhibitorshandbook.com/download-graphic-templates>

### Shipping

Packing box(es):  
1 Box

Box size:  
48" l x 12" h x 5" d  
1220mm(l) x 305mm(h) x 127mm(d)

Approximate shipping weight:  
16 lbs / 8 kg

## additional information:

Graphic material:  
Dye-sublimation zipper pillowcase fabric

When included in a larger kit, a different packaging solution will be listed to accommodate all contents of the kit. Individual packaging no longer provided.

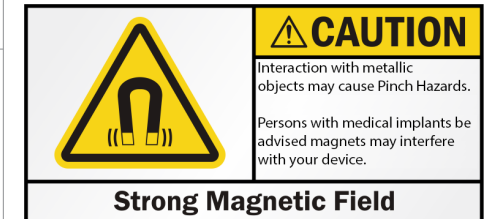

Use caution when handling this product around mechanical wrist watches, metal tools, electronic devices, credit cards or any other similar items. DO NOT place any part of the body, such as fingers, hands, etc, between the magnetic surface areas of the components.



This product may include the following materials for recycle:  
aluminum, select wood, fabric, cardboard, paper, steel, and plastics.

1 person assembly recommended:



We are continually improving and modifying our product range and reserve the right to vary the specifications without prior notice. All dimensions and weights quoted are approximate and we accept no responsibility for variance. E&OE. See Graphic Templates for graphic bleed specifications.

\*Not to scale

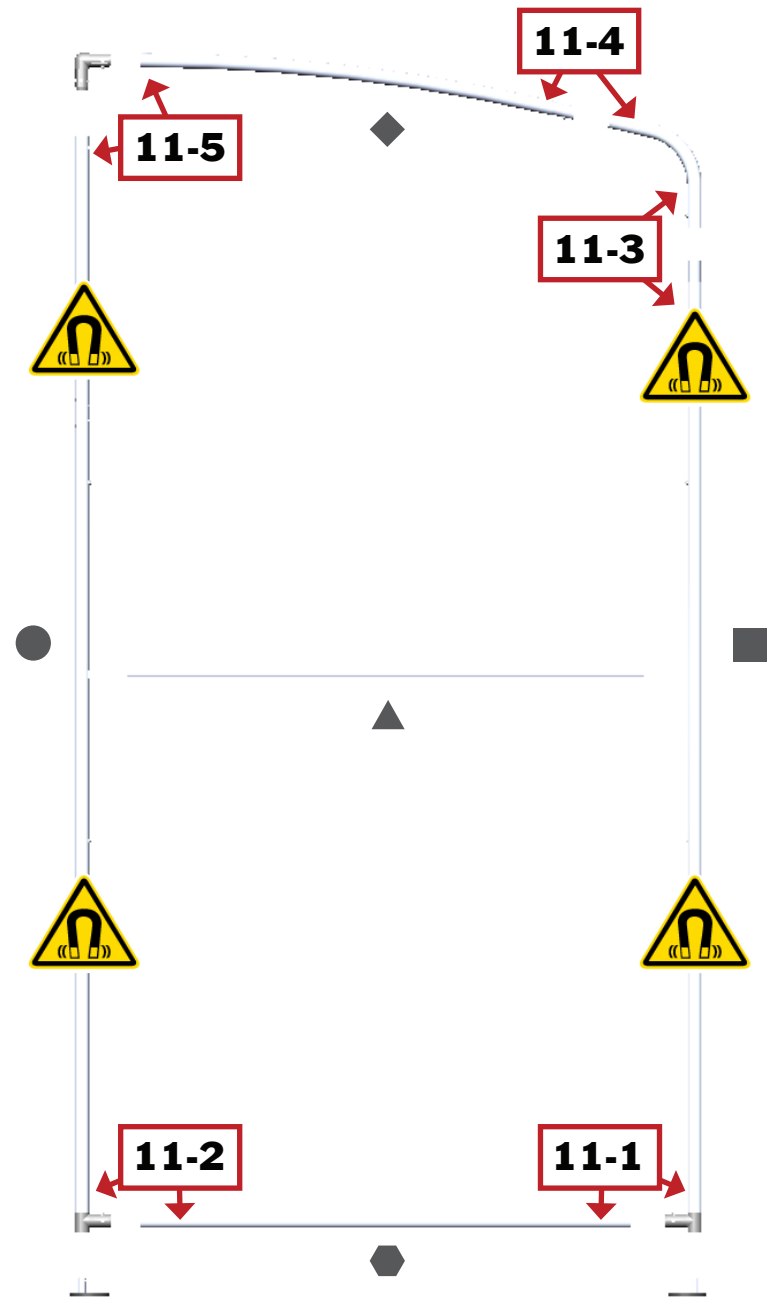
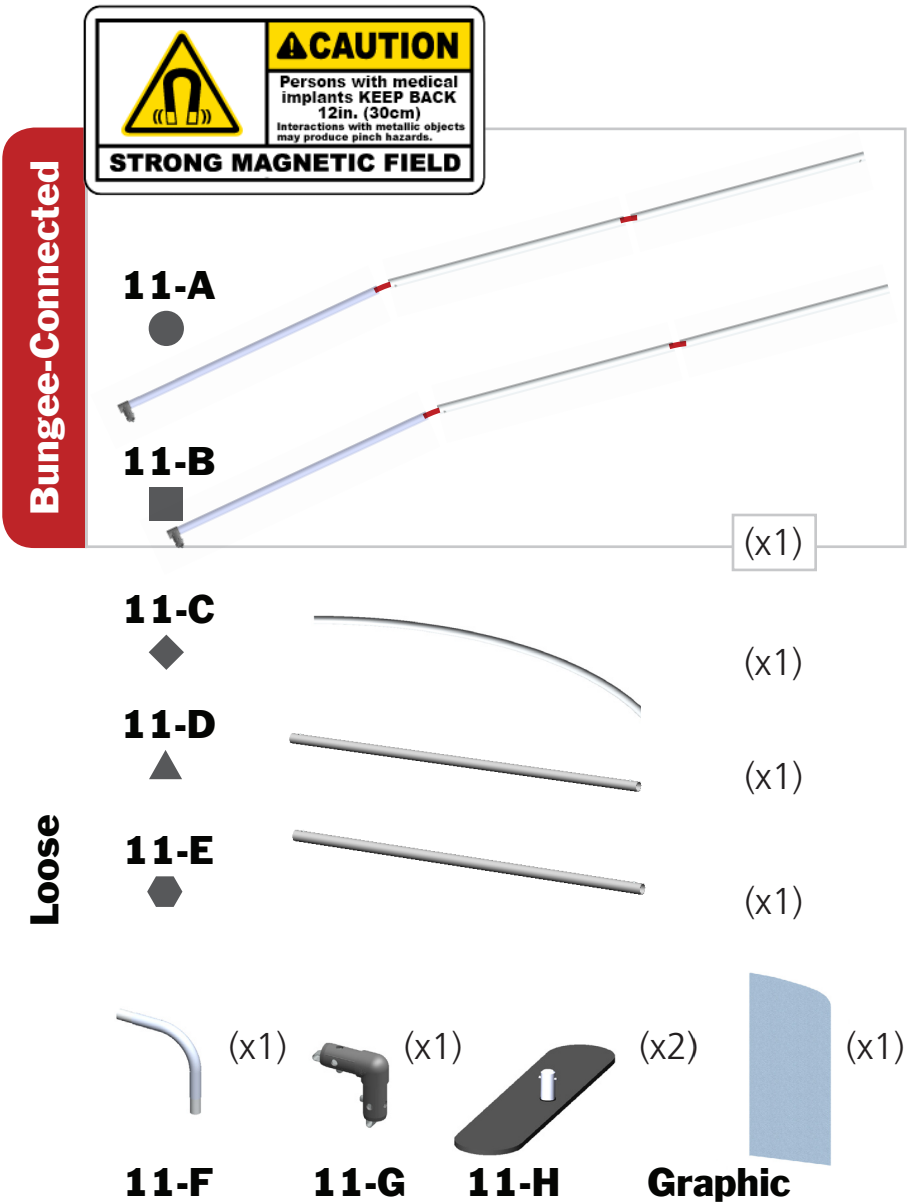

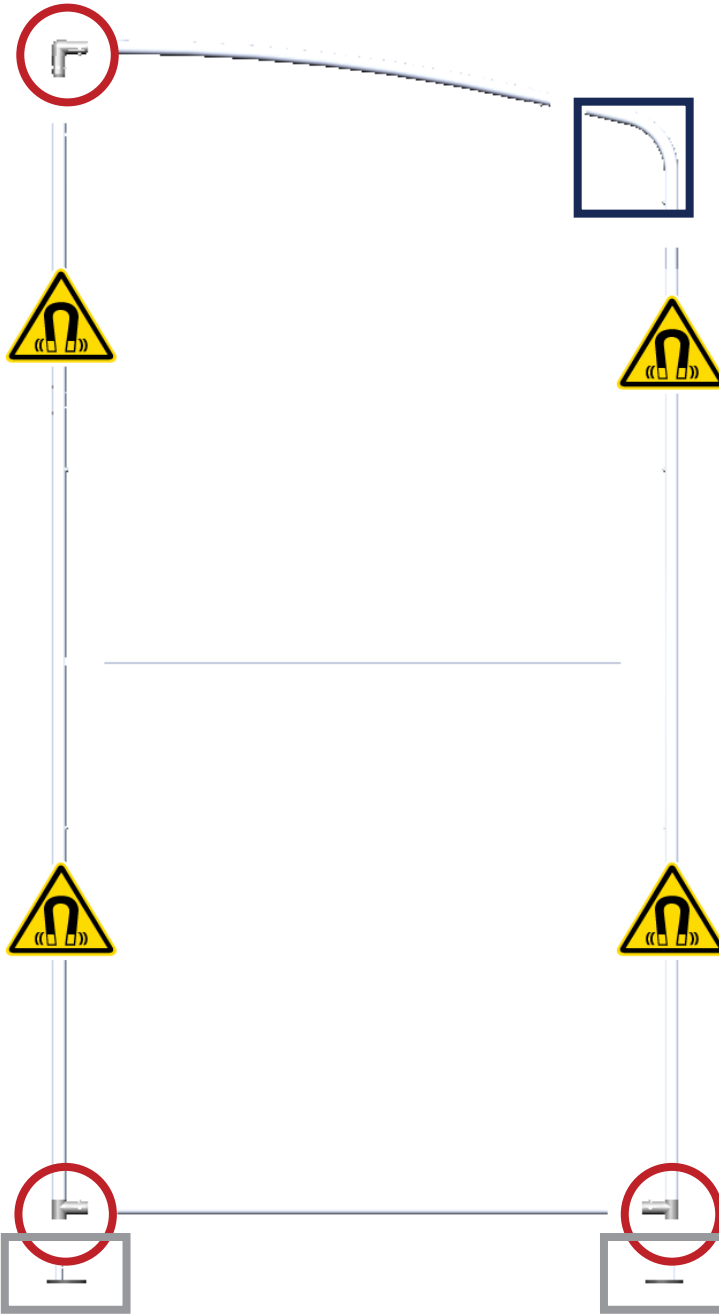
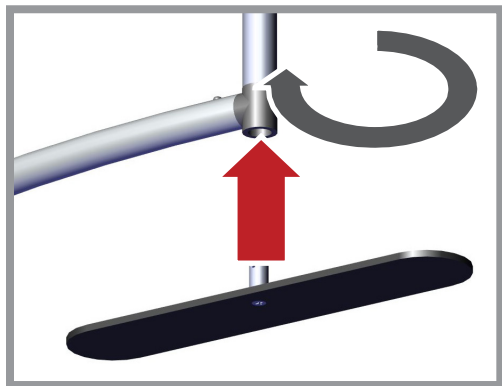
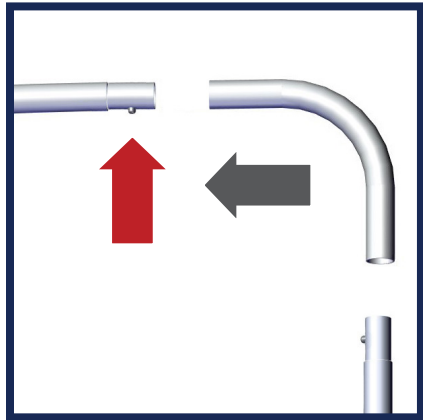
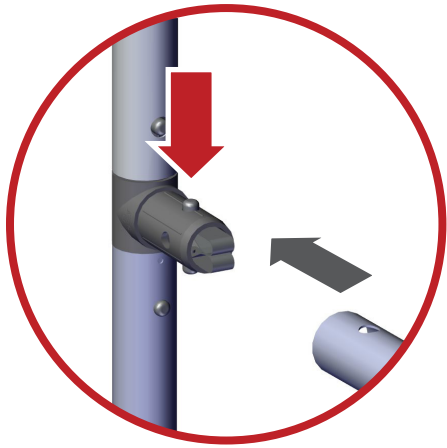

**Graphic**

